

03CA001

Material: PVC ShA 55

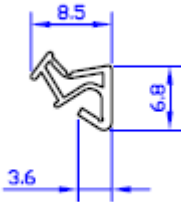

\*\*\*\*\*

03CA002

Material: PVC ShA 55



\*\*\*\*\*

03CA003

Material: PVC ShA 55

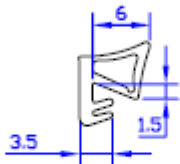

\*\*\*\*\*

03CA004

Material: PVC ShA 55

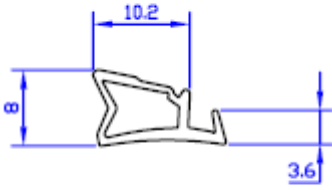

\*\*\*\*\*

03CA005

Material: PVC ShA 55



\*\*\*\*\*

03CA006

Material: PVC ShA 55

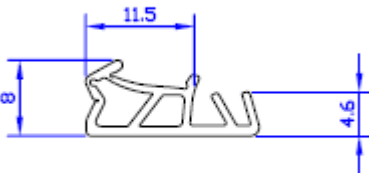

\*\*\*\*\*

03CA007

Material: PVC ShA 55

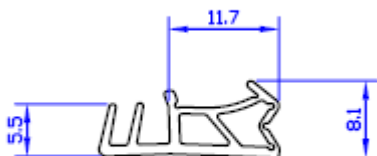

\*\*\*\*\*

03CA008

Material: PVC ShA 55

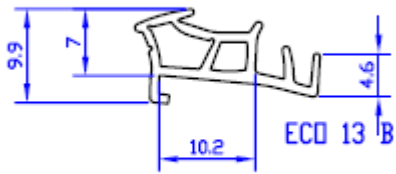

\*\*\*\*\*

03CA009

Material: PVC ShA 55

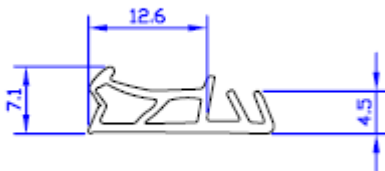

\*\*\*\*\*

03CA010

Material: PVC ShA 55

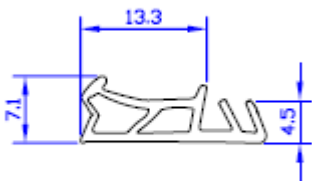

\*\*\*\*\*

03CA011

Material: PVC ShA 55

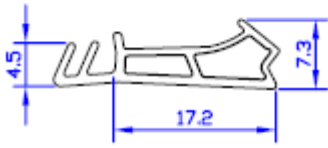

\*\*\*\*\*

03CA012

Material: PVC ShA 55

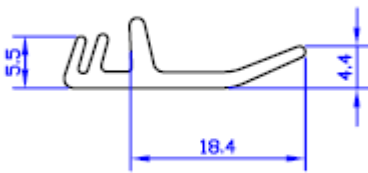

\*\*\*\*\*

03CA013

Material: PVC ShA 55

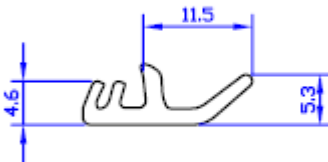

\*\*\*\*\*

03CA016

Material: PVC ShA 55



\*\*\*\*\*

03CA028

Material: PVC ShA 55

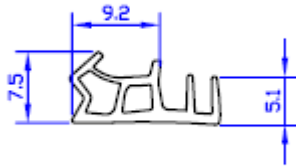

\*\*\*\*\*

03CB017

Material: PVC ShA 55

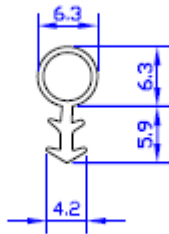

\*\*\*\*\*

03CB018

Material: PVC ShA 55

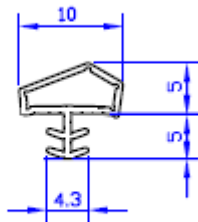

\*\*\*\*\*

03CB019

Material: PVC ShA 55

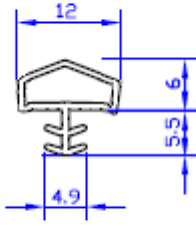

\*\*\*\*\*

03CB020

Material: PVC ShA 55

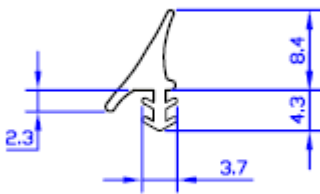

\*\*\*\*\*

03CB022

Material: PVC ShA 55

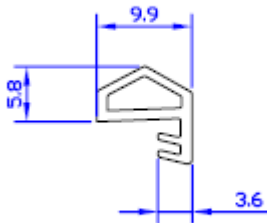

\*\*\*\*\*

03CB025

Material: PVC ShA 55

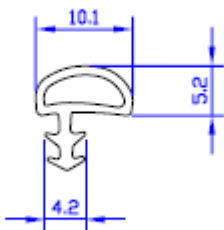

\*\*\*\*\*

03CB026

Material: PVC ShA 55

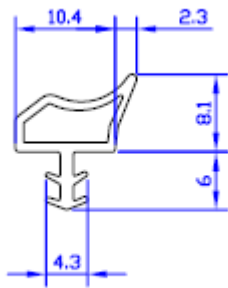

\*\*\*\*\*

03CB027

Material: PVC ShA 55

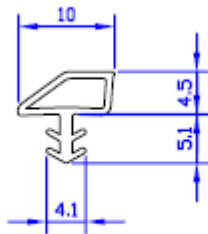

\*\*\*\*\*

03CG015

Material: PVC ShA 60

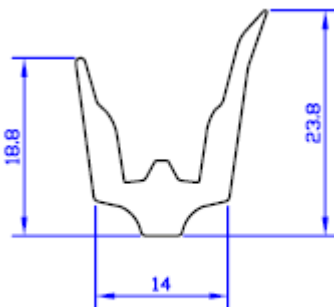

\*\*\*\*\*

03CG029

Material:

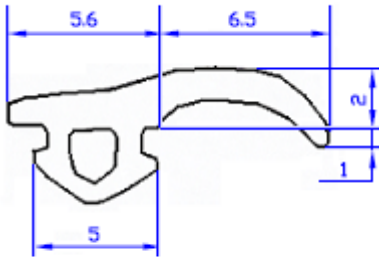

\*\*\*\*\*

03CG030

Material:

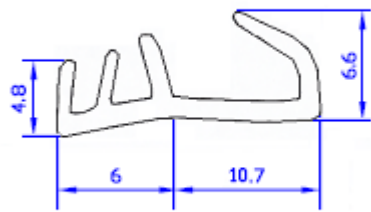

\*\*\*\*\*

03CG031

Material:

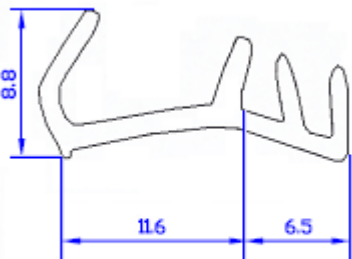

\*\*\*\*\*

03CG032

Material:

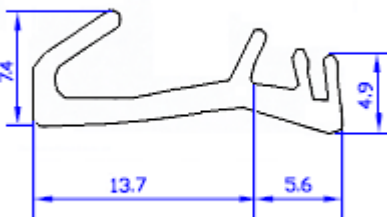

\*\*\*\*\*



03GG014

Material: PVC ShA 80

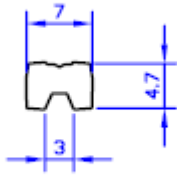

\*\*\*\*\*

04CB021

Material: PVC ShA 93 + PVC ShA 65

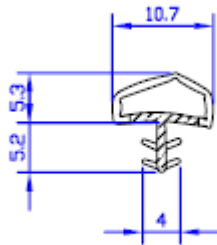

\*\*\*\*\*

04CB023

Material: PVC ShA 93 + PVC ShA 65

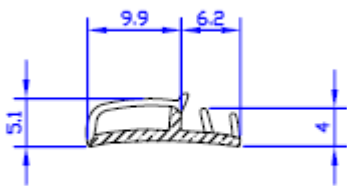

\*\*\*\*\*

05CA048

Material:

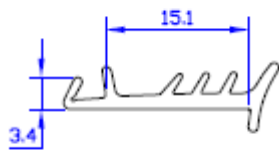

\*\*\*\*\*

05CA049

Material: TPE ShA 63

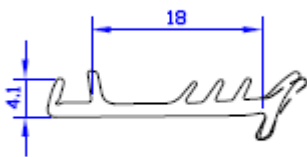

\*\*\*\*\*

05CA059

Material: TPE ShD 30 + TPE ShA 63

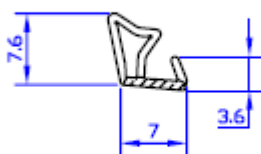

\*\*\*\*\*

05CA061

Material:

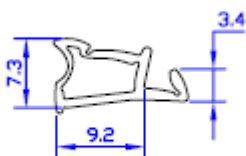

\*\*\*\*\*

05CA062

Material: TPE ShA 63

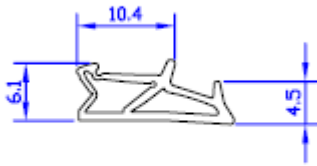

\*\*\*\*\*

05CA063

Material: TPE ShA 63

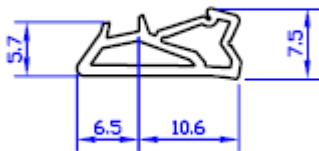

\*\*\*\*\*

05CA064

Material: TPE ShA 63

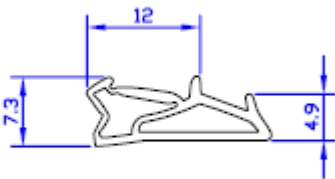

\*\*\*\*\*

05CA065

Material: TPE ShA 63

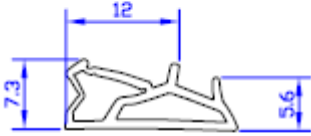

\*\*\*\*\*

05CA066

Material:

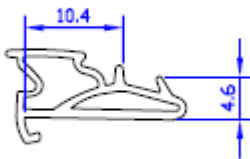

\*\*\*\*\*

05CA067

Material: TPE ShA 63

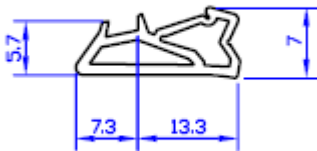

\*\*\*\*\*

05CA068

Material: TPE ShA 63

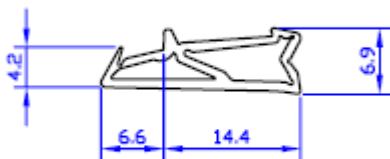

\*\*\*\*\*

05CA069

Material: TPE ShA 63

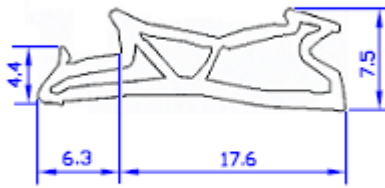

\*\*\*\*\*

05CA070

Material: TPE ShA 63

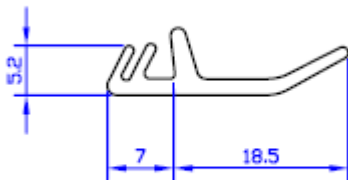

\*\*\*\*\*

05CA071

Material: TPE ShA 63

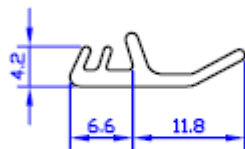

\*\*\*\*\*

05CG033

Material: TPE ShA 63

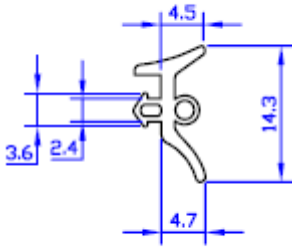

\*\*\*\*\*

05CG034

Material: TPE ShA 63

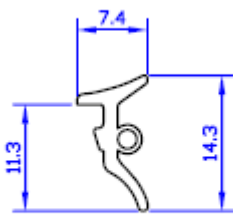

\*\*\*\*\*

05CG035

Material: TPE ShA 63

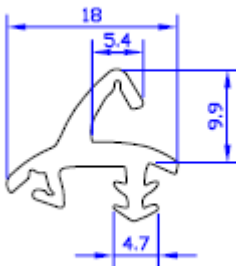

\*\*\*\*\*

05CG036

Material: TPE ShA 63

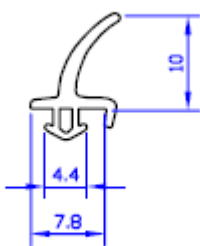

\*\*\*\*\*

05CG037

Material: TPE ShA 63

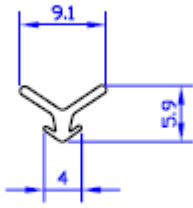

\*\*\*\*\*

05CG038

Material: TPE ShA 63

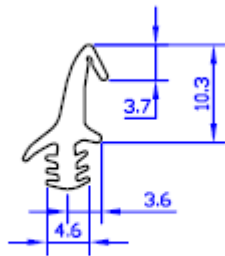

\*\*\*\*\*

05CG039

Material: TPE ShA 63

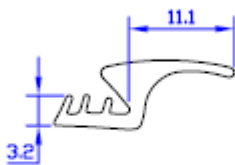

\*\*\*\*\*

05CG040

Material: TPE ShA 63

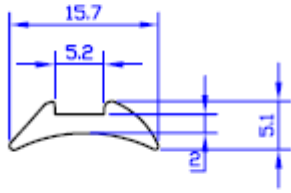

\*\*\*\*\*

05CG041

Material: TPE ShA 63

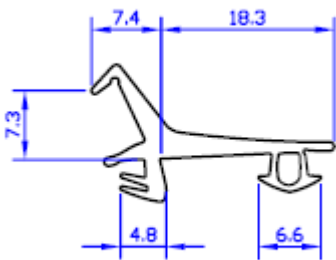

\*\*\*\*\*

05CG042

Material: TPE ShA 63

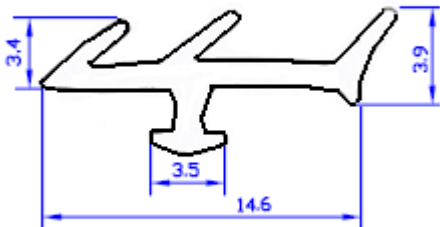

\*\*\*\*\*

05CG043

Material: TPE ShA 63

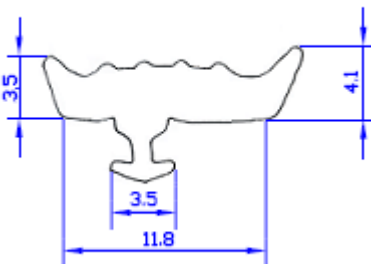

\*\*\*\*\*



05CG044

Material: TPE ShA 63

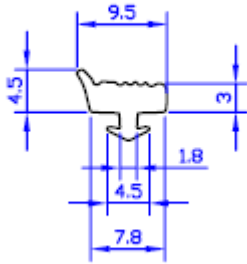

\*\*\*\*\*

05CG045

Material: TPE ShA 63

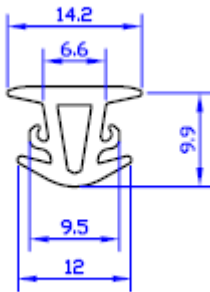

\*\*\*\*\*

05CG046

Material:

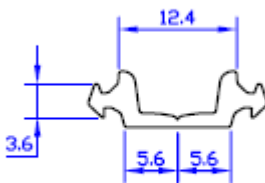

\*\*\*\*\*

05CG047

Material:

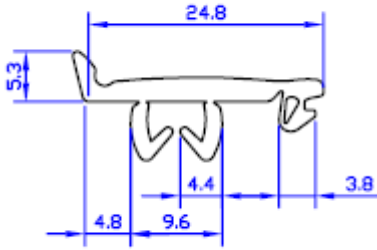

\*\*\*\*\*

05CG050

Material: TPE ShA 63

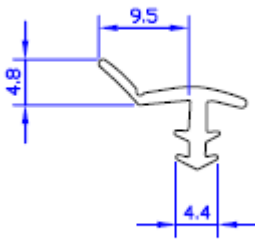

\*\*\*\*\*

05CG051

Material: TPE ShA 63

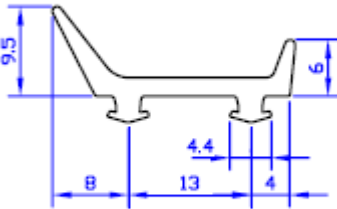

\*\*\*\*\*

05CG052

Material: TPE ShA 63

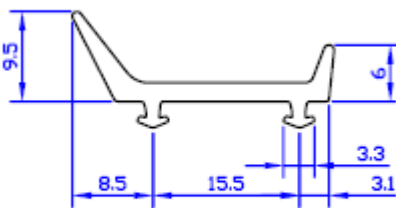

\*\*\*\*\*

05CG056

Material:

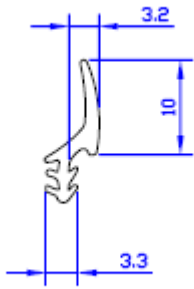

\*\*\*\*\*

06CG053

Material: PP+TPE ShA 63

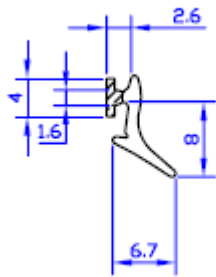

\*\*\*\*\*

06CG054

Material: TPE ShD 40 + TPE ShA 60

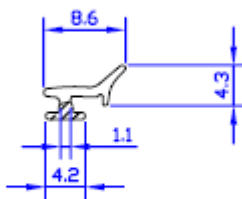

\*\*\*\*\*

06CG055

Material: TPE ShD 40 + TPE ShA 63

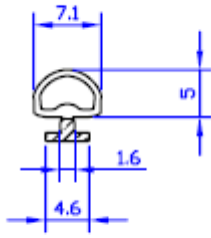

\*\*\*\*\*

3-500

Material: PVC ShA 55

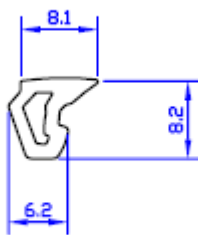

\*\*\*\*\*

BAT10

Material: PVC ShA 55

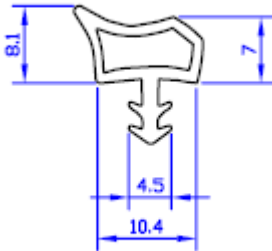

\*\*\*\*\*

HA08

Material: PVC ShA 55



\*\*\*\*\*

HTS045

Material: TPE ShA 63

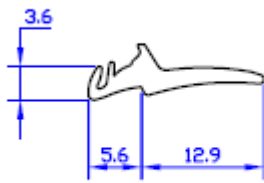

\*\*\*\*\*

SAP

Material: PVC ShA 90 + PVC ShA 65

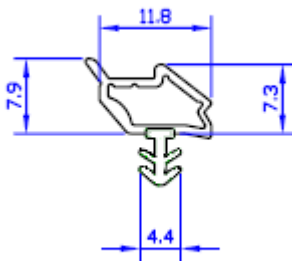

\*\*\*\*\*

T12

Material: TPE ShD 30 + TPE ShA 63

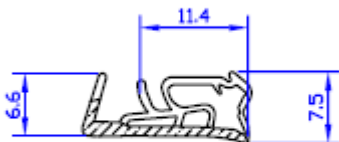

\*\*\*\*\*

5523

Material: PVC 55ShA

5523

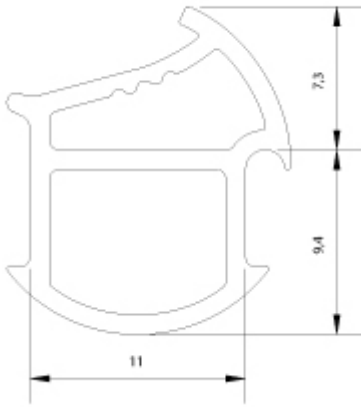

\*\*\*\*\*

HSE 1

Material: TPE 63ShA

HSE 1

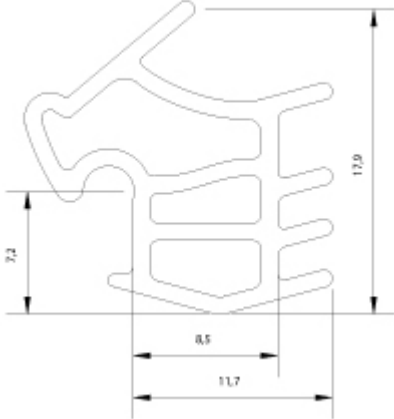

\*\*\*\*\*

R1

Material: TPE 63ShA

R1

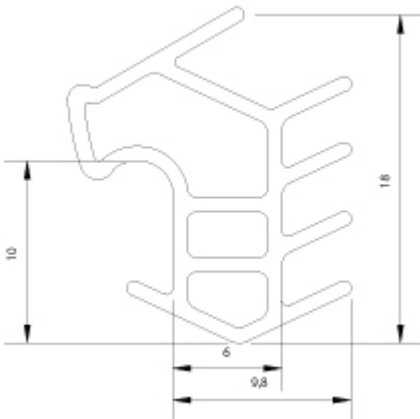

\*\*\*\*\*

ALU006

Material: PVC 55ShA

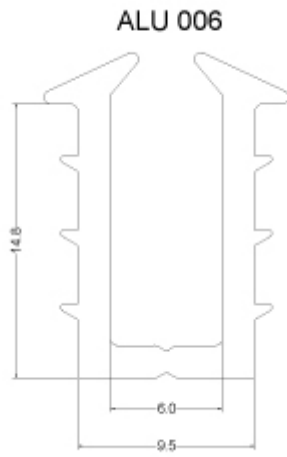

\*\*\*\*\*

Tesenie 4mm  
Material: PVC 93ShA

**TESNENIE 4mm**

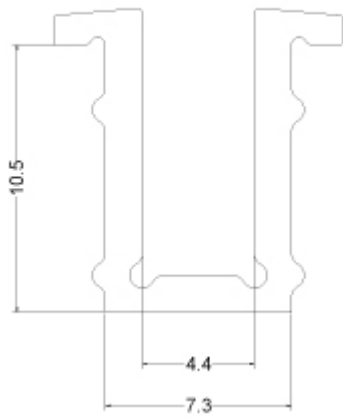

\*\*\*\*\*

Tesenie 5mm  
Material: PVC 93ShA

**TESNENIE 5mm**

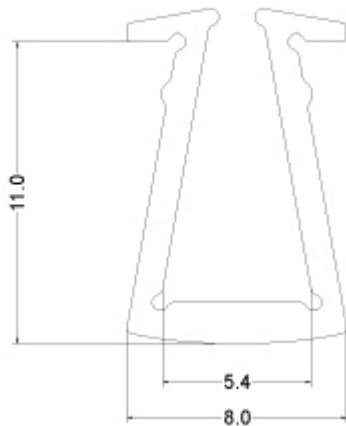

\*\*\*\*\*

TU TR  
Material: PVC

### TU TR

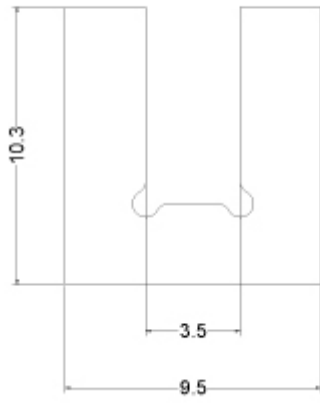

\*\*\*\*\*

U profil  
Material: PVC

### U profil

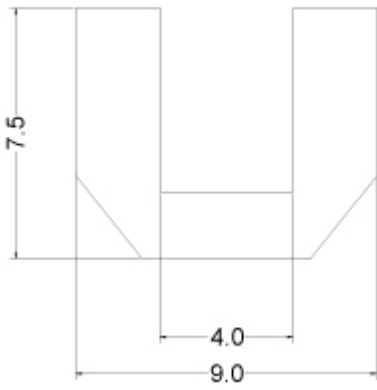

\*\*\*\*\*